

**MODEL:** CPE-270 | **DESCRIPTION:** PIEZO BUZZER INDICATOR**FEATURES**

- wire leads with panel-mount tabs
- 12 Vdc rating
- 3.5 kHz rated frequency

**SPECIFICATIONS**

parameter	conditions/description	min	typ	max	units
rated voltage			12		Vdc
operating voltage		3		28	Vdc
current consumption	at rated voltage			5	mA
rated frequency		3,000	3,500	4,000	Hz
sound pressure level	at 30 cm, rated voltage	86			dB
dimensions	Ø33.7 x 14.5				mm
weight				7.0	g
material	ABS UL94 1/16" HB High Heat (black)				
terminal	wire leads				
operating temperature		-30		85	°C
storage temperature		-40		95	°C
RoHS	2011/65/EU				

Notes: 1. All specifications measured at 5~35°C, humidity at 45~85%, under 86~106kPa pressure, unless otherwise noted.

## MECHANICAL DRAWING

units: mm  
tolerance: ±0.5 mm

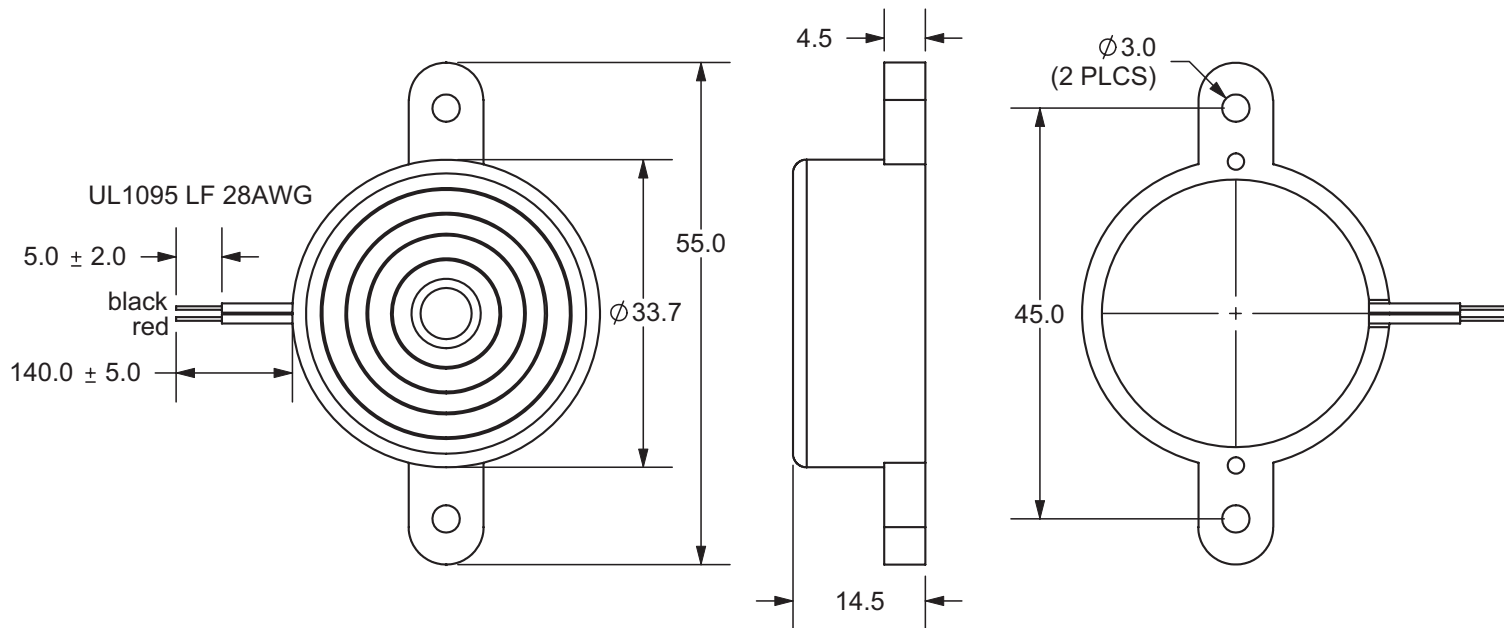

## PERFORMANCE CURVES

P: Voltage vs. Sound Pressure Level  
I: Voltage vs. Current Consumption

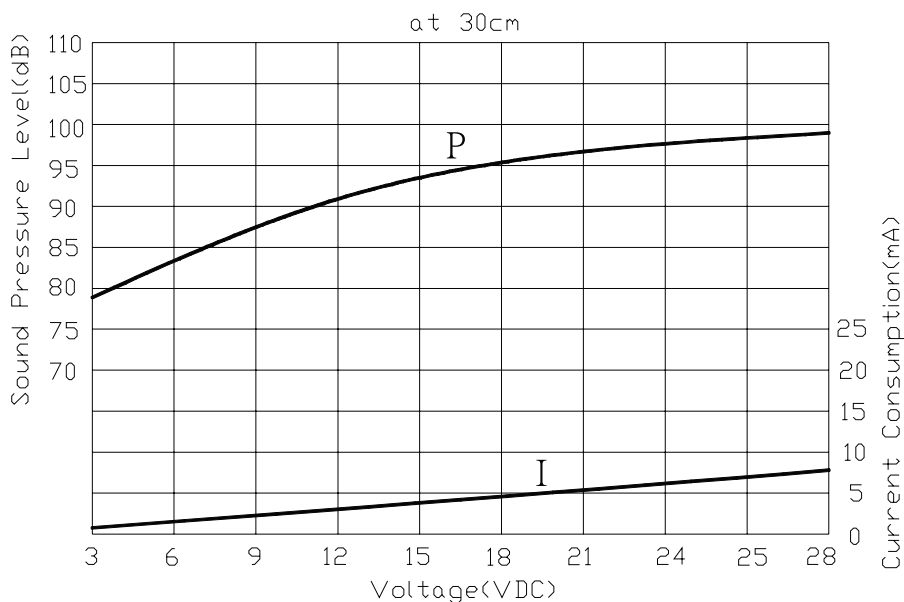

## REVISION HISTORY

---

rev.	description	date
1.0	initial release	11/12/2007
1.01	applied new spec template	06/16/2015

The revision history provided is for informational purposes only and is believed to be accurate.



**CUI INC**<sup>®</sup>

**Headquarters**  
20050 SW 112th Ave.  
Tualatin, OR 97062  
**800.275.4899**

Fax 503.612.2383  
**cui.com**  
techsupport@cui.com

CUI offers a one (1) year limited warranty. Complete warranty information is listed on our website.

CUI reserves the right to make changes to the product at any time without notice. Information provided by CUI is believed to be accurate and reliable. However, no responsibility is assumed by CUI for its use, nor for any infringements of patents or other rights of third parties which may result from its use.

CUI products are not authorized or warranted for use as critical components in equipment that requires an extremely high level of reliability. A critical component is any component of a life support device or system whose failure to perform can be reasonably expected to cause the failure of the life support device or system, or to affect its safety or effectiveness.